

Spot-lights



Made in Finland

www.candeeffect.com

Candee E.

We reserve the right
to make changes to
our products.



LedSpot55

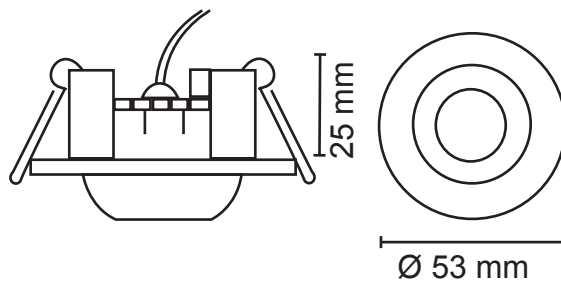

white



chrome



nickel



gold

Frame	Adjustable spot of aluminum
Power	Constant current 350 mA led driver
Connection	Must be wired in series
Operating temperature	- 40 °C - + 60 °C
Life time	100.000 h with a 30 % decrease in luminous flux
Warranty	Light unit: 6 years

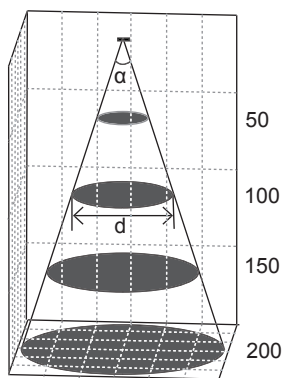

Warm White	Beam angle 19 °	CRI 80
Distance (cm)	Illuminance maximum (lx)	Beam width (d)
50 cm	790	17 cm
100 cm	210	34 cm
150 cm	90	49 cm
200 cm	50	66 cm

Cool White	Beam angle 18 °	CRI 70
Distance (cm)	Illuminance maximum (lx)	Beam width (d)
50 cm	1210	16 cm
100 cm	320	31 cm
150 cm	150	45 cm
200 cm	80	62 cm

Neutral White	Beam angle 17 °	CRI 80
Distance (cm)	Illuminance maximum (lx)	Beam width (d)
50 cm	1180	15 cm
100 cm	310	29 cm
150 cm	140	44 cm
200 cm	80	58 cm

	Luminous flux of
warm white	60 lm
neutral white	70 lm
cool white	90 lm

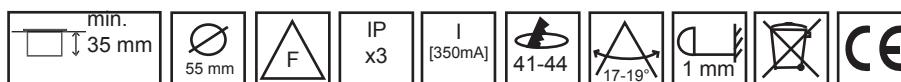

Product code	Model		Colour	W	K	Led
CEL310 204 103	LedSpot55	Light unit	warm white	1,25	2800	Rebel
CEL310 204 203	LedSpot55	Light unit	neutral white	1,25	4000	Rebel
CEL310 204 303	LedSpot55	Light unit	cool white	1,25	6000	Rebel
CEL710 055 010	Frame55	White				
CEL710 055 020	Frame55	Gold				
CEL710 055 030	Frame55	Nickel				
CEL710 055 040	Frame55	Crome				



We reserve the right to make changes to our products.

Candeo L.

Made in Finland
www.candeeffect.com



LedSpot100

Led Light unit

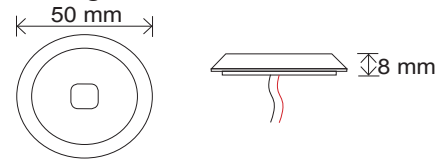

LedSpot100; round, fixed frame

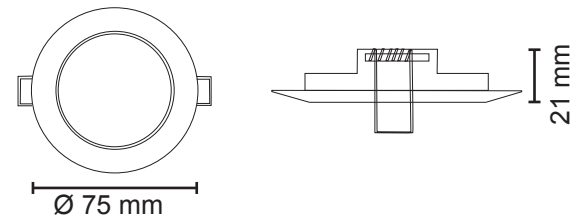

white

steel

Optional: gold, satin gold, chrome, satin chrome, bronze

LedSpot100; round, adjustable frame

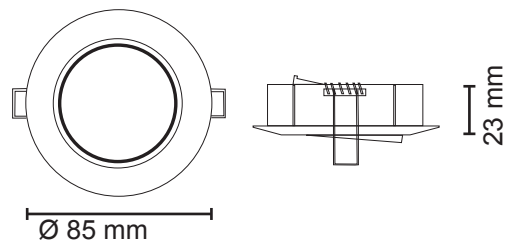

white



steel

Optional: gold, satin gold, chrome, satin chrome, bronze

Frame	Aluminum frame, fixed or adjustable
Power	Constant current 350 mA or 700 mA
Connection	Must be wired in series
Operating temperature	- 40 °C - + 60 °C
Life time	100.000 h with a 30 % decrease in luminous flux
Warranty	Lighr unit: 6 years

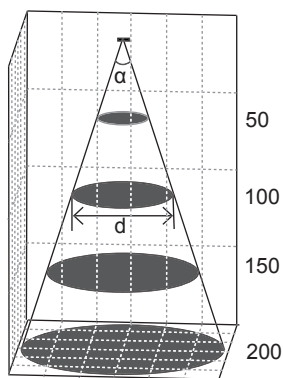

Warm White	Beam angle 38 °	CRI 80
Distance (cm)	Illuminance maximum (lx) 350 / 700 mA	Beam width (d)
50 cm	230 / 380	33 cm
100 cm	60 / 98	66 cm
150 cm	25 / 44	99 cm
200 cm	15 / 25	131 cm

Cool White	Beam angle 33 °	CRI 70
Distance (cm)	Illuminance maximum (lx) 350 / 700 mA	Beam width (d)
50 cm	415 / 670	30 cm
100 cm	105 / 170	60 cm
150 cm	45 / 75	89 cm
200 cm	25 / 40	119 cm

Neutral White	Beam angle 35 °	CRI 80
Distance (cm)	Illuminance maximum (lx) 350 / 700 mA	Beam width (d)
50 cm	305 / 490	31 cm
100 cm	80 / 125	62 cm
150 cm	35 / 55	93 cm
200 cm	20 / 31	125 cm

	Luminous flux of the light source 350 / 700 mA
warm white	60 / 100 lm
neutral white	60 / 100 lm
cool white	90 / 150 lm

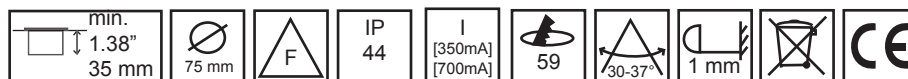

LedSpot100; round, fixed frame

Product code	Model		Colour	W (350/700 mA)	K	Led
CEL310 214 174	Halled3	Light unit	warm white	1,25 / 2,25	2800	Rebel
CEL310 214 274	Halled3	Light unit	neutral white	1,25 / 2,25	4000	Rebel
CEL310 214 374	Halled3	Light unit	cool white	1,25 / 2,25	6000	Rebel
CEL710 100 010	Frame100P	White				
CEL710 100 060	Frame100P	Steel				

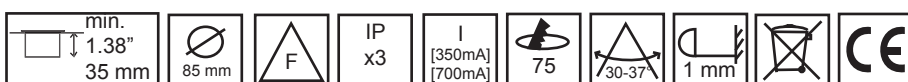

LedSpot100; round, adjustable

Product code	Model		Colour	W (350/700 mA)	K	Led
CEL310 214 174	Halled3	Light unit	warm white	1,25 / 2,25	2800	Rebel
CEL310 214 274	Halled3	Light unit	neutral white	1,25 / 2,25	4000	Rebel
CEL310 214 374	Halled3	Ligth unit	cool white	1,25 / 2,25	6000	Rebel
CEL710 101 010	Frame100PK	White				
CEL710 101 060	Frame100PK	Steel				



We reserve the right to make changes to our products.

Candeo L.

Made in Finland

www.candeeffect.com

LedSpot100; square, adjustable frame

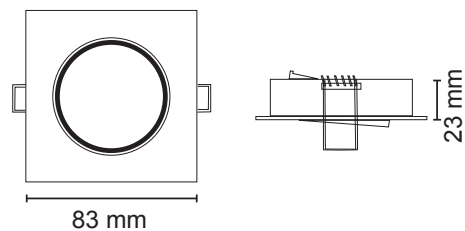

white

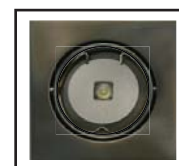

steel

LedSpot100; square, with glass

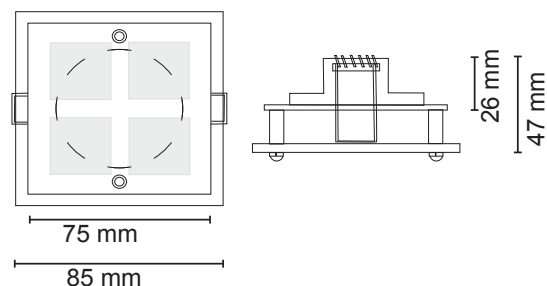

Glass with shape
Frame: chrome

Frame	Aluminum frame, fixed or adjustable
Power	Constant current 350 mA or 700 mA
Connection	Must be wired in series
Operating temperature	- 40 °C - + 60 °C
Life time	100.000 h with a 30 % decrease in luminous flux
Warranty	Light unit: 6 years

LedSpot100



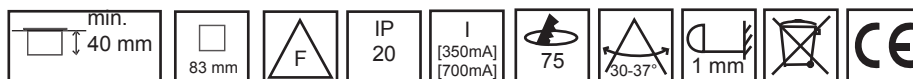

LedSpot100; square, adjustable frame

Product code	Model		Colour	W (350 / 700 mA)	K	Led
CEL310 214 174	Halled3	Light unit	warm white	1,25 / 2,25	2800	Rebel
CEL310 214 274	Halled3	Light unit	neutral white	1,25 / 2,25	4000	Rebel
CEL310 214 374	Halled3	Lighth unit	cool white	1,25 / 2,25	6000	Rebel
CEL710 111 010	Frame100NK	White				
CEL710 111 060	Frame100NK	Steel				



LedSpot100; square, with glass

Product code	Model		Colour	W (350 / 700 mA)	K	Led
CEL310 214 174	Halled3	Light unit	warm white	1,25 / 2,25	2800	Rebel
CEL310 214 274	Halled3	Light unit	neutral white	1,25 / 2,25	4000	Rebel
CEL310 214 374	Halled3	Light unit	cool white	1,25 / 2,25	6000	Rebel
CEL710 120 040	Frame100L	Chrome + glass				





ThinSQ7

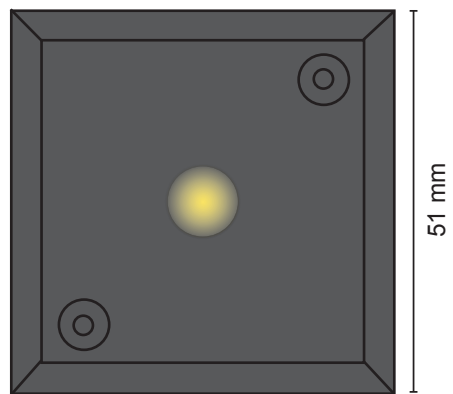
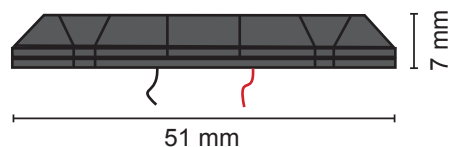

Frame	Painted aluminum (RAL9006) For special order: other colours
Power	Constant current 350 mA or 700 mA
Connection	Must be wired in series
Operating temperature	- 40 °C - + 60 °C
Life time	100.000 h with a 30 % decrease in luminous flux
Warranty	Light unit: 6 years

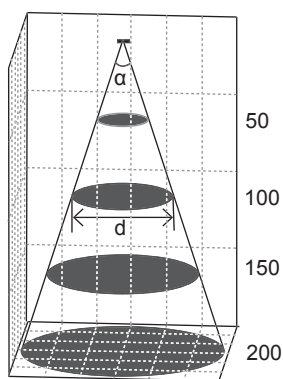

Warm White	Beam angle 29 °	CRI 80
Distance (cm)	Illuminance maximum (lx) 350 / 700 mA	Beam width (d)
50 cm	280 / 480	26 cm
100 cm	70 / 120	51 cm
150 cm	30 / 54	77 cm
200 cm	15 / 30	103 cm

Cool White	Beam angle 26 °	CRI 70
Distance (cm)	Illuminance maximum (lx) 350 / 700 mA	Beam width (d)
50 cm	620 / 1115	23 cm
100 cm	155 / 280	45 cm
150 cm	70 / 125	69 cm
200 cm	40 / 71	92 cm

Neutral White	Beam angle 25 °	CRI 80
Distance (cm)	Illuminance maximum (lx) 350 / 700 mA	Beam width (d)
50 cm	350 / xx	22 cm
100 cm	90 / xx	45 cm
150 cm	40 / xx	68 cm
200 cm	20 / xx	90 cm

	Luminous flux of the light source 350 / 700 mA
warm white	60 / 100 lm
neutral white	70 / xx lm
cool white	90 / 150 lm



ThinSQ7; surface mount

Product code	Model	Frame	Colour	W (350 / 700 mA)	K	Led
CEL110 212 175	ThinSQ7	Aluminum RAL9006	warm white	1,25 / 2,25	2800	Rebel
CEL110 212 275	ThinSQ7	Aluminum, RAL9006	neutral white	1,25 / 2,25	4000	Rebel
CEL110 212 375	ThinSQ7	Aluminum, RAL9006	cool white	1,25 / 2,25	6000	Rebel



Drivers

Product code	CEL07391
Type	LED 10W DC 350 mA Aluminium housing
Number of LEDs	1 - 7 (LEDsin series)
Casing	Aluminium casing
Dimension (mm)	23 x 40 x 81
Weight	165 g
Tc Max	90° C
Connection	Output / Input wires
Load	1 -10VA
Input	120-240V 50Hz
Output current	350 mA
Output voltage	2 - 29 V
	IP67
Warranty	4 years
Manufacturer	Lightech

LED10W DC 350mA,
Aluminium casing

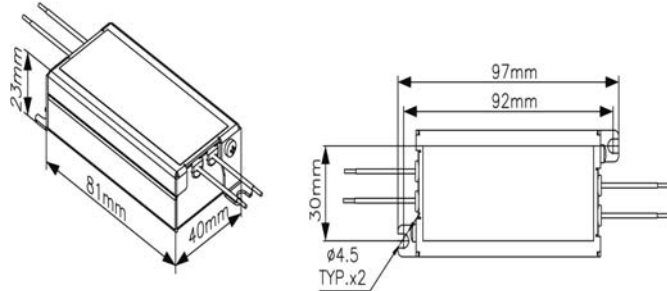

Product code	CEL07392
Type	LED 10W DC 350 mA
Number of LEDs	1 - 7 (LEDs in series)
Casing	Plastic casing
Dimension (mm)	27 x 40 x 100
Weight	90 g
Tc Max	90° C
Connection	Terminal block connection
Load	1 -10VA
Input	120-240V 50Hz
Output current	350 mA
Output voltage	2 - 29 V
Warranty	4 years
Manufacturer	Lightech
	Only inside use

LED10W DC 350mA,
Plastic casing

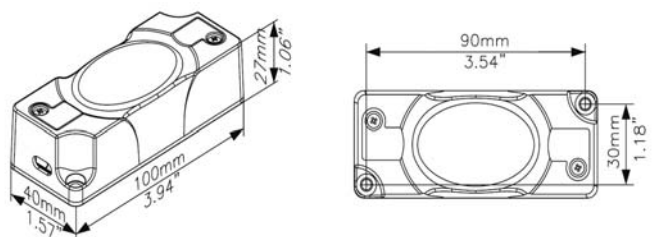

Product code	CEL07393
Type	LED 10W DC 350 mA Plug-in
Number of LEDs	1 - 7 (LEDs in series)
Casing	Plastic casing (silver)
Dimension (mm)	33 x 38 x 80
Weight	150 g
Tc Max	90° C
Connection	Output 1,5 m double insulated wire
Load	1 -10VA
Input	95-265V 50Hz
Output current	350 mA
Output voltage	2 - 28 V
Warranty	4 years
Manufacturer	Lightech

LED10W DC 350mA,
Plug-In

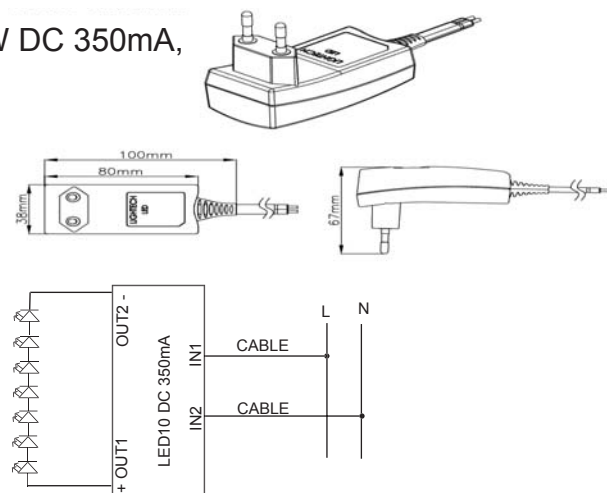

Product code	CEL10041
Type	LED 18W DC 350 mA Aluminium housing
Number of LEDs	4 - 12 (LEDs in series)
Dimming	1 - 10 V Dimming control
Casing	Aluminium casing
Dimension (mm)	30,5 x 40 x 133
Weight	300 g
Tc Max	90° C
Connection	Output / Input wires
Input	240V 50Hz
Output current	350 mA
Output voltage	8 - 48 V
	IP67
Warranty	4 years
Manufacturer	Lightech

LED18W DC 350mA

From 4 to 12 leds
in series.

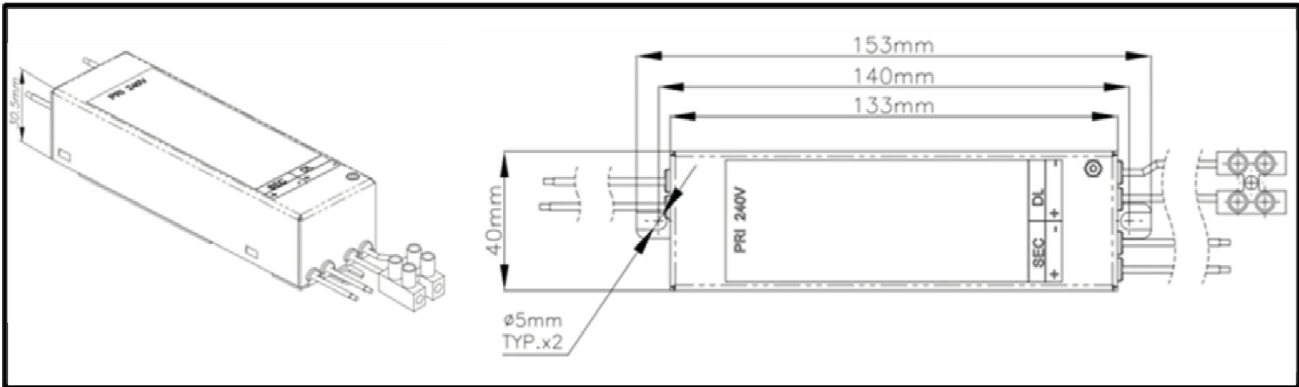
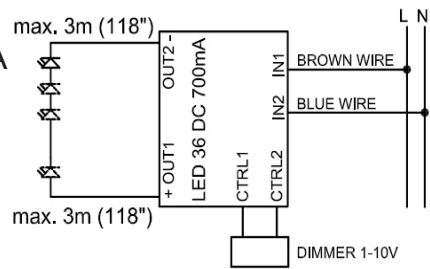

Product code	CEL10042
Type	LED 36W DC 700 mA Aluminium housing
Number of LEDs	4 - 12 LEDs in series
Dimming	1 - 10 V Dimming control
Casing	Aluminium casing
Dimension (mm)	30,5 x 40 x 133
Weight	300 g
Tc Max	90° C
Connection	Output / Input wires
Input	240V 50Hz
Output current	700 mA (4 - 12 LEDs)
Output voltage	8 - 48 V
	IP67
Warranty	4 years
Manufacturer	Lightech

LED36W DC 700mA

LED 700mA
From 4 to 12 leds
in series.

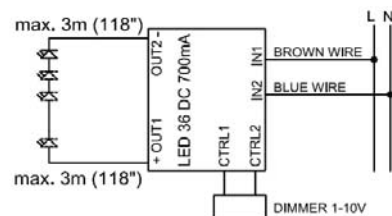

Manufacturer:
Savled /Diranet Oy
Laitaatsillantie 3
57170 SAVONLINNA
FINLAND
Tel.+358 15 555 0031

Made in Finland

www.candeeffect.com

Candee E.

We reserve the right
to make changes to
our products.